

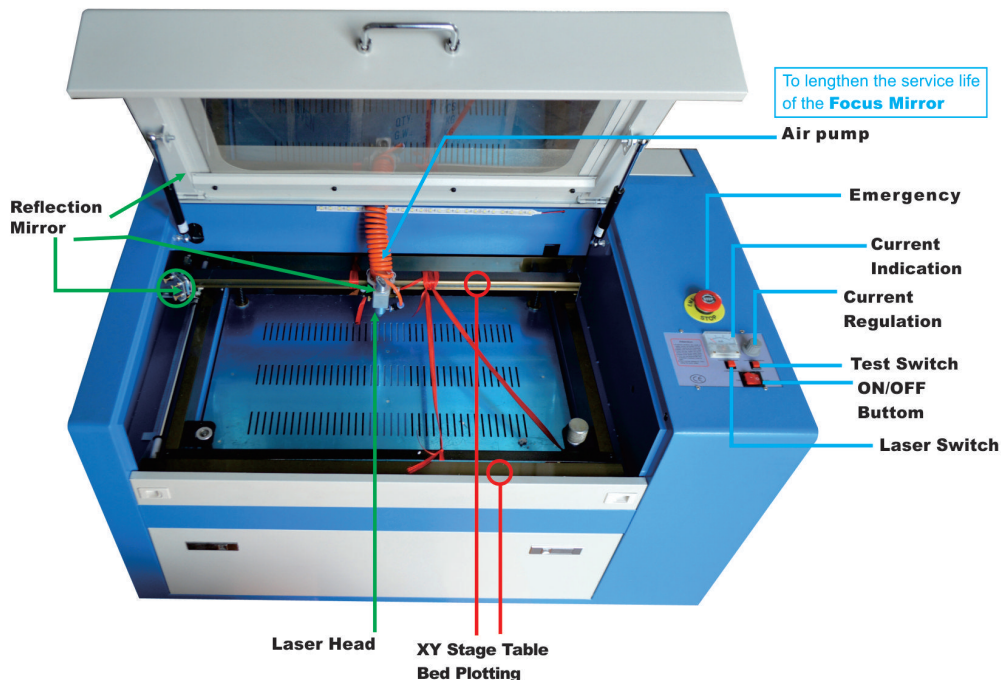

CO2 LASER ENGRAVING MACHINE INSTRUCTION

50W (110V)



So glad that you buy our laser machine , please operating according to the following instructions .

Please handle the laser machine with care,because the laser glass tube is fixed into the machine,it is fragile

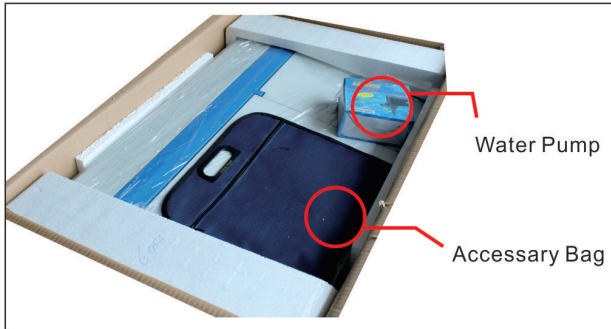

#1

Don't connect to the power supply first, according to the following steps :

1 - Take out laser machine, open the front lid of the machine . Then take out the four parts.

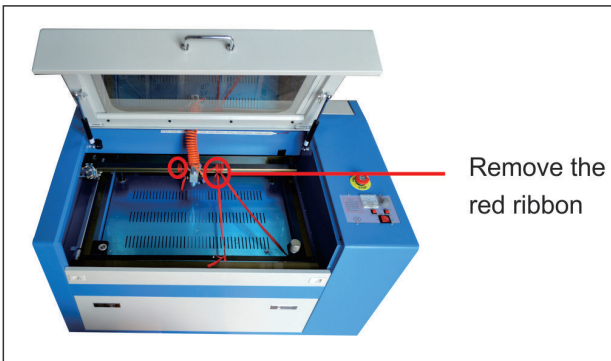

2 - Check the laser reflective mirror and lens to see if there is sundry, dust.Clean it with alcohol.You should clean the laser machine after a period of time .

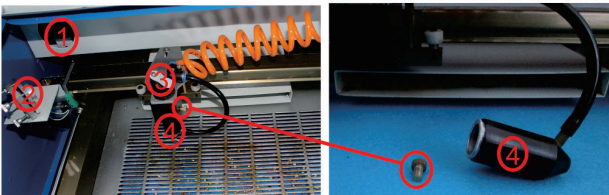

Laser head could be removed if you loosen the screw

1,2 ,3, Reflection Mirror
4, Φ 18mm Focus Len(Easy to take down)

3 - Put the laser machine smoothly, first take a bucket of water ,connect the pump to the laser machine.Then put pump to the bucket (water in bucket should higher than the pump)

4 - Connect exhaust fan to the slot behind the laser machine.

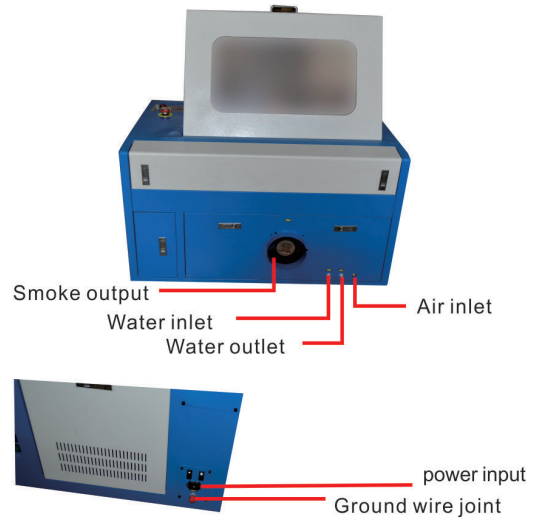

6 - Connected the power supply of pump (Should pay more attention to the safety of the electricity). There are some bubbles at first.

7 - Connected the power supply of blowing air pump.(110V)

8 - Connected the power supply of exhaust fan.(110V)

9 - Check "Current regulating" .Be sure the current is minimum (Clockwise to increase and counterclockwise to reduce)

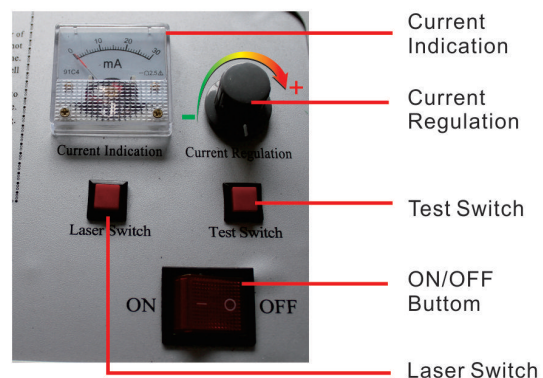

10 - Connected the power supply of laser machine , press "on", laser plotter automatic back to zero.

11 - Turn on the "laser switch", if not out of the laser, please turn up "Current Regulation", then test, until the laser light.According to the different material adjustment of cutting and engraving laser current size.

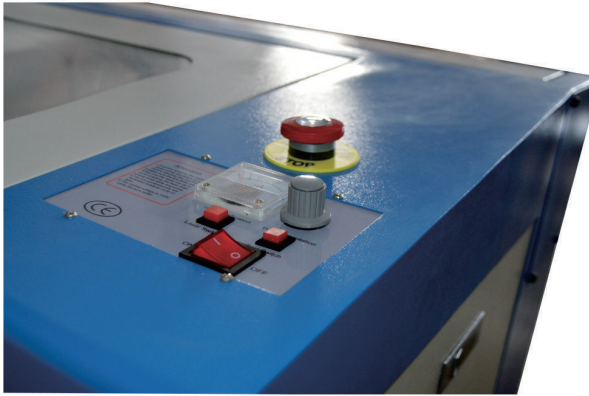

Installation Of The Software

In order to run Corelaser you need to install CoreIDRAW. It need CoreIDRAW12 or higher.

- ★ **One:** Connect the laser machine and encryption dog to computer.
Then turn on the computer and laser machine



USB Line



Safe Dog
Connect the computer



Two: Software Installation

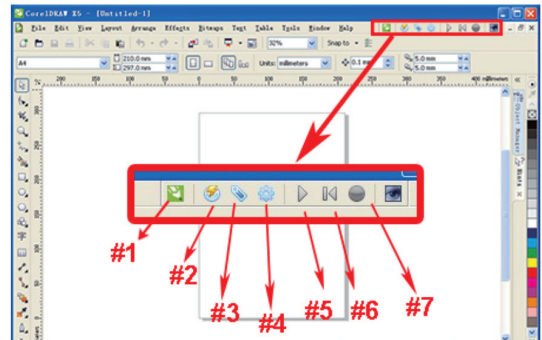

- #1 Data Setting #2 Engraving #3 Cutting
- #4 Engraving Machine Properties #5 Task Waiting
- #6 Reset #7 Stop

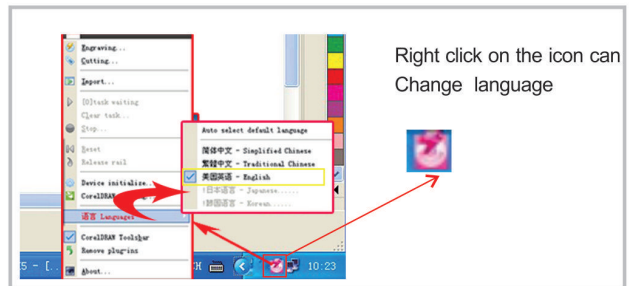

★ Three: Software Setting Up

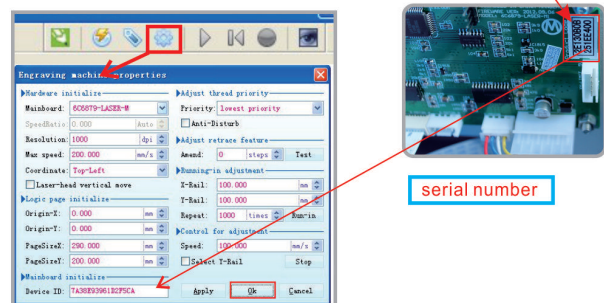
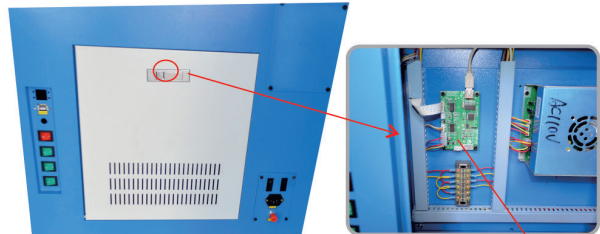

According to the picture, open the laser machine and input the number on the main board into the software.

Parallel digital port : A right side of the engraver , the port will connect relevant port on the computer through printing cable .

Air Pump port : Keep the lens clean ;
Prevent the carving material from burning.

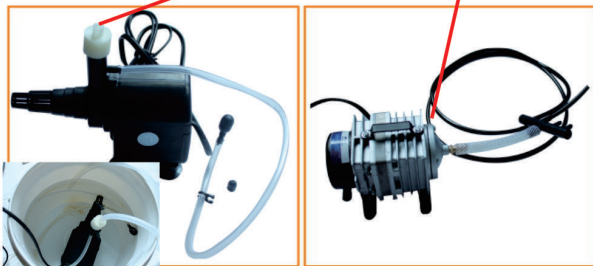

Water Pump

Air Pump

Water-cooling pipe port : It is for the circulation of cooling water . To lengthen the service life of the laser tube , purified water is promoted .

Fan port : At the hinder of the engraver and used for the installation of exhaust fan . The fan must be correctly installed for the cleanness of the machine .

Applicable Industry

This machine is suitable to seal engraving, advertisement, art gift, garment, leather, toy, building upholster, computerized embroidery, packing and printing, paper product, garments sampling, large width tailoring, shoemaking, furniture, industry, craftwork, nameplates decorations, woodcut and other industries.

Introduction

This machine employs a USB port and thus can be connected to your laptop or desktop. By the support of included software ,this machine can work well with multiple graphic formats including EMF /JPG/PLT/WMF.

This brand new DC-KIII CO2 laser engraver is equipped with one 40W water cooling laser tube, high precise stepping motors, high quality control board. The Computerized Mini Laser Engraving and Cutting Machine is suitable for various materials, such as bamboo piece, double-color planks, boulder, horns, leather, crystal, wood, organic plastic, abrics, paper ,film, canvas , Acrylic and Plastics.

Parameters

Laser Type: CO2 Gas
Tube Trigger Volt: 20KV
Tube Operating Volt: 15KV
Current: 0~22mA
Engraving Area: 300x500mm
Laser Tube (life hours): 1000-1300 Hours
Laser Power: 50W
Engraving Speed: 0-13.8 in./s (0-350mm/s)
Cutting Speed: 0-1.38 in./s (0-35mm/s)
Minimum Shaping Character: 0.04 X0.04in (1mm X 1mm)
Resolution Ratio: 0.001 in (0.026mm) / (1000dpi)

List of all Frequently Asked Questions.

in order of addition to archive:

How to clean a Lens?

Use denatured alcohol and Q-Tips. Softly apply the alcohol. Allow the alcohol to evaporate as you swirl the Q-Tip to remove dissolved filth.

How long does the Laser tube last?

Rated for up to 3000 hours .. and experiencing more hours.

What focal lens comes with the laser machine?

18mm

What is the advantages of the laser head?

Adjust the upper and lower position of laser focus, meet different thickness of engraving.



Power Wire



USB Wire



Instruction

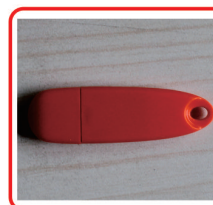

safe dog

Connect the computer

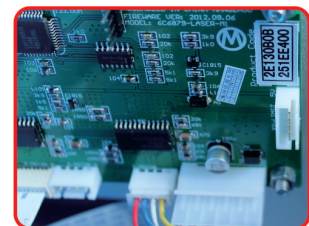

serial number

It works (cuts) great on the left side and fades to nothing on the right side. Any ideas?

Optical Path Adjustment

After let all power cables connect well and electrify, turn on the engraving machine power supply, at this time, the machine starts to reset and return to the last origin point. All above shows that the machine is running normally, then turn on the "laser Switch", *As shown in Fig.F2-13*

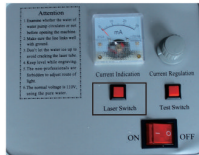

F2-13

Begin to adjust the optical path. *As shown in Fig.F2-14*

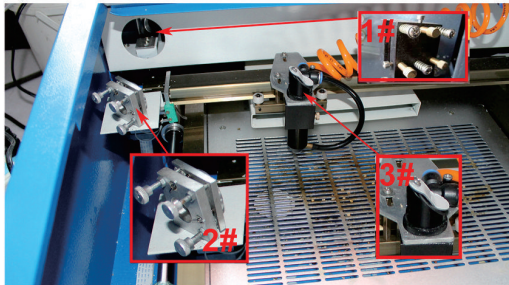

F2-14

Alignment Standards of Optical Path

During common use, there may appear some deviation with the optical path, resulting in no laser or light path is abnormal, then please refer to the following method to adjust the optical path:

Step one: First to ensure laser beam from laser tube to the center of 1# reflector mirror.

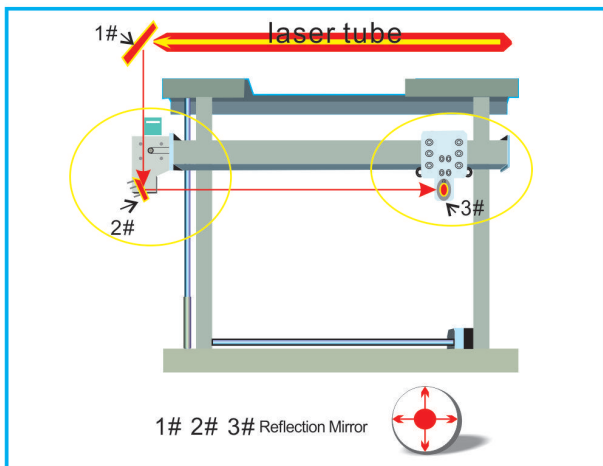

Step two: Affix multi-storey double sticky tape paper on the 2# reflector (Or other objects can be marked on), move laser beam to closest location of laser tube, press pulse (choose suitable power), get a spot on the paper (with special attention: In order to prevent the laser radiation wounding, with a piece of cardboard first to test the approximate location of the spot, and then adjust).

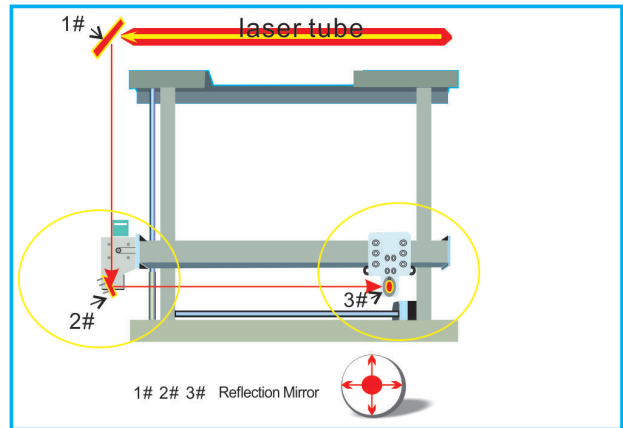

Step three: Move away the beam to the position far from the laser tube, press pulse, get another spot on the paper.

Step four: If the two spots are not superposition, adjust the screws on the back of the 1#mirror to make the laser fire on the same position as the first spot.

Step five: Repeat the second to the fourth steps until the two spots overlap completely. Moreover, the spots should be in the center of the hole.

Step six: Affix multi-storey double sticky tape paper on the 3# reflector, move laser head to the nearest position from 2# mirror, press pulse (choose suitable power), get a spot on the paper.

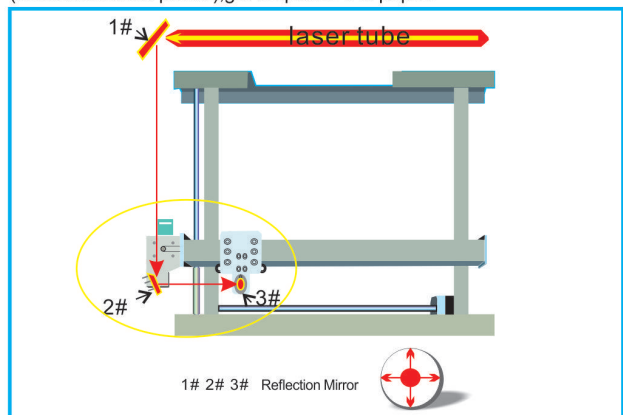

Step seven: Move away the laser head to the position farthest from the 2# mirror, press pulse (first to detect the approximate location of laser with a piece of cardboard to prevent wounding), get another spot.

Step eight: If the two spots are not superposition, adjust the screws on the back of the 2# mirror to make the laser fire on the same position as the first spot. Step nine: Repeat the sixth to eighth steps until the two spots overlap completely. Moreover, the spots should be in the center of the hole. Step ten: Affix multi-storey double sticky tape paper on the 3# reflector, press pulse, get a spot on the paper. If it is in the center of light hole, then pass.

Step XI: If the laser light is not in the center of light hole, as below figure:

In the left Figure, the spot is upper and right biased. Top to bottom bias: can only raise or lower the laser tube. Inside and outside bias: only move the laser tube in or out to adjust. In this case, it is essential to lower the laser tube (here refers to low-voltage side of the laser tube), and then, from the beginning of all the re-adjustment of the first step.



Note: The operator can't do the above working until after the professional training. Otherwise, the operator do this working must with the help of the professional. The operator must pay attention to security when adjusting, to prevent the laser radiation wounding.

First to ensure laser beam from laser tube to the center of 1# reflector mirror.

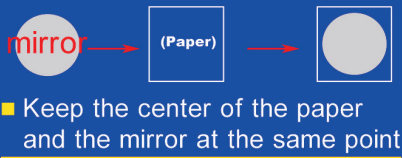
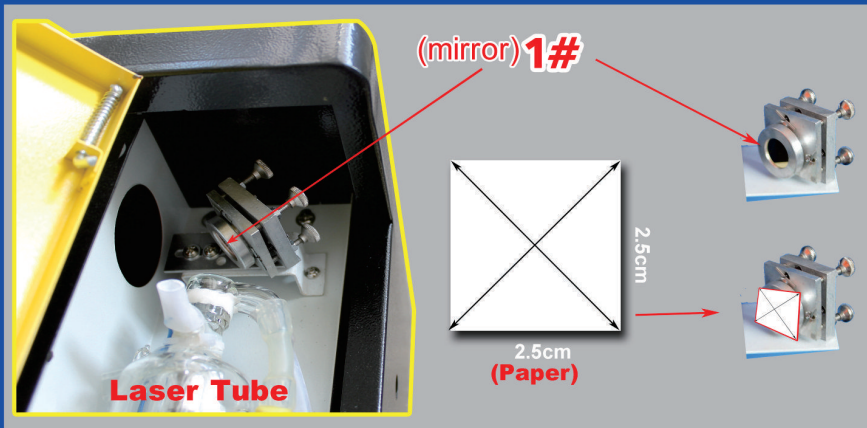

Keep the center of the paper and the mirror at the same point

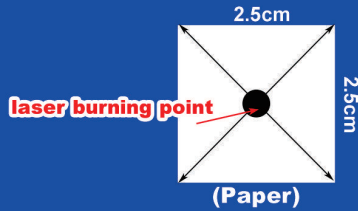

It is the best results if laser can leave a mark at the center of the test paper

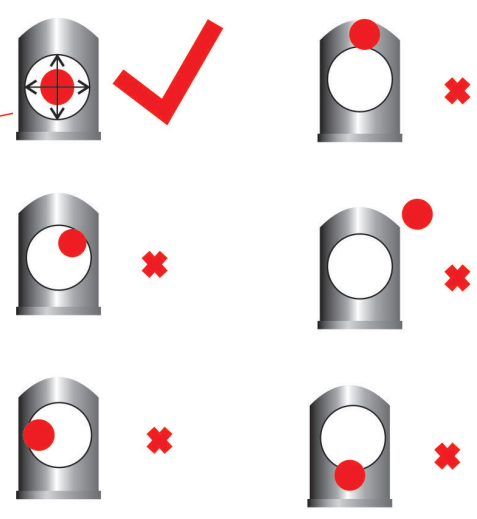
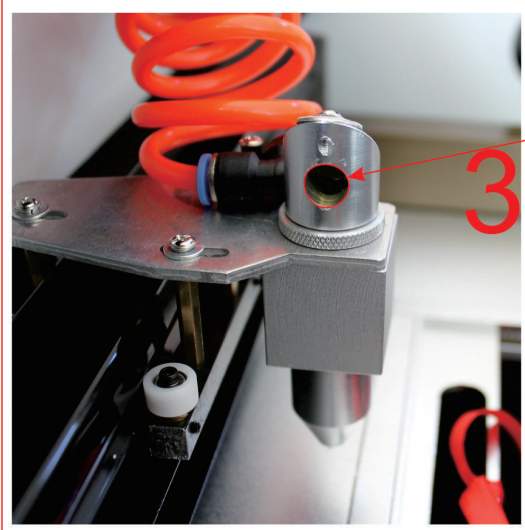
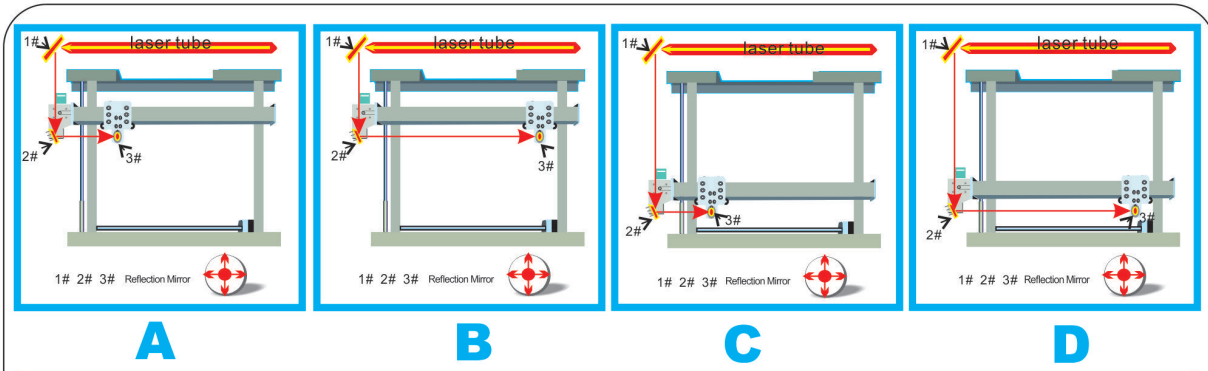

The laser must hit the center of the 3# in the four pictures above(A,B,C,D)

It works (cuts) great on the left side and fades to nothing on the right side. Any ideas?

Optical Path Adjustment

After let all power cables connect well and electrify, turn on the engraving machine power supply, at this time, the machine starts to reset and return to the last origin point. All above shows that the machine is running normally, then turn on the "laser Switch", *As shown in Fig.F2-13*

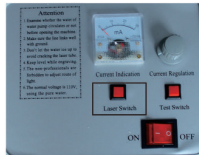

F2-13

Begin to adjust the optical path. *As shown in Fig.F2-14*

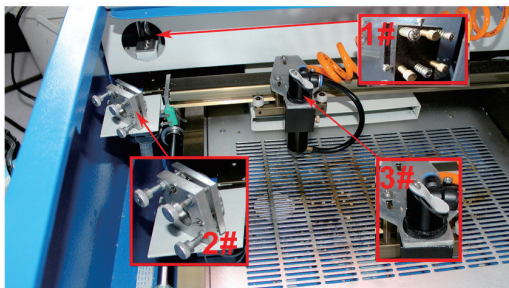

F2-14

Alignment Standards of Optical Path

During common use, there may appear some deviation with the optical path, resulting in no laser or light path is abnormal, then please refer to the following method to adjust the optical path:

Step one: First to ensure laser beam from laser tube to the center of 1# reflector mirror.

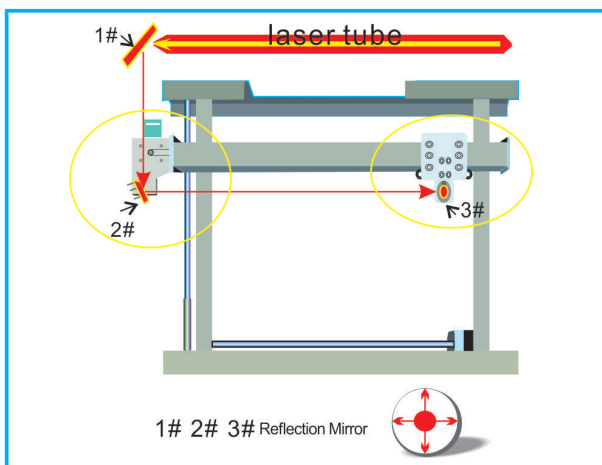

Step two: Affix multi-storey double sticky tape paper on the 2# reflector (Or other objects can be marked on), move laser beam to closest location of laser tube, press pulse (choose suitable power), get a spot on the paper (with special attention: In order to prevent the laser radiation wounding, with a piece of cardboard first to test the approximate location of the spot, and then adjust).

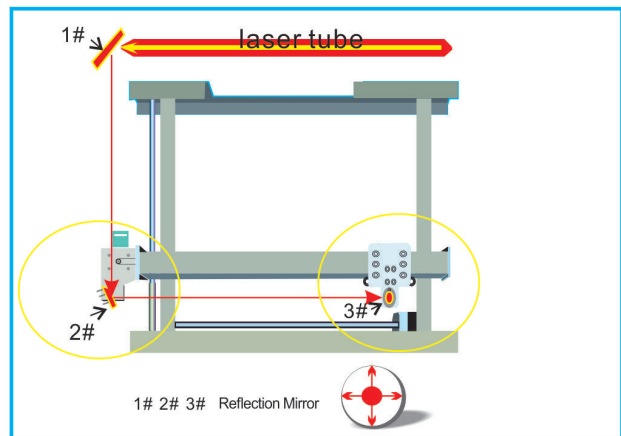

Step three: Move away the beam to the position far from the laser tube, press pulse, get another spot on the paper.

Step four: If the two spots are not superposition, adjust the screws on the back of the 1#mirror to make the laser fire on the same position as the first spot.

Step five: Repeat the second to the fourth steps until the two spots overlap completely. Moreover, the spots should be in the center of the hole.

Step six: Affix multi-storey double sticky tape paper on the 3# reflector, move laser head to the nearest position from 2# mirror, press pulse (choose suitable power), get a spot on the paper.

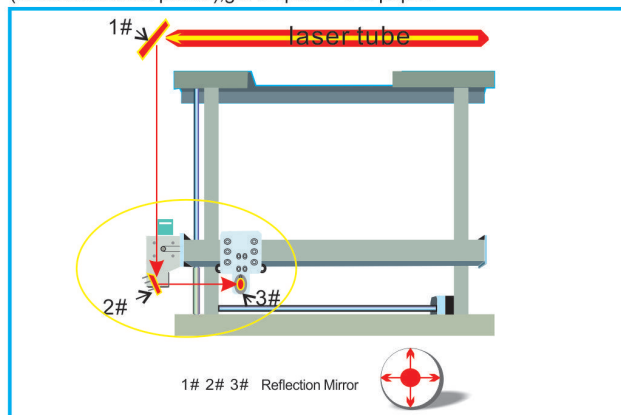

Step seven: Move away the laser head to the position farthest from the 2# mirror, press pulse (first to detect the approximate location of laser with a piece of cardboard to prevent wounding), get another spot.

Step eight: If the two spots are not superposition, adjust the screws on the back of the 2# mirror to make the laser fire on the same position as the first spot. Step nine: Repeat the sixth to eighth steps until the two spots overlap completely. Moreover, the spots should be in the center of the hole. Step ten: Affix multi-storey double sticky tape paper on the 3# reflector, press pulse, get a spot on the paper. If it is in the center of light hole, then pass.

Step XI: If the laser light is not in the center of light hole, as below figure:

In the left Figure, the spot is upper and right biased. Top to bottom bias: can only raise or lower the laser tube. Inside and outside bias: only move the laser tube in or out to adjust. In this case, it is essential to lower the laser tube (here refers to low-voltage side of the laser tube), and then, from the beginning of all the re-adjustment of the first step.

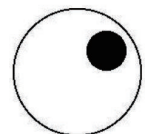

Note: The operator can't do the above working until after the professional training. Otherwise, the operator do this working must with the help of the professional. The operator must pay attention to security when adjusting, to prevent the laser radiation wounding.

