

*Yaesu*

EVOLUTION OF AUTO TAPE DISPENSER

# ZCUT-9

INSTRUCTION MANUAL

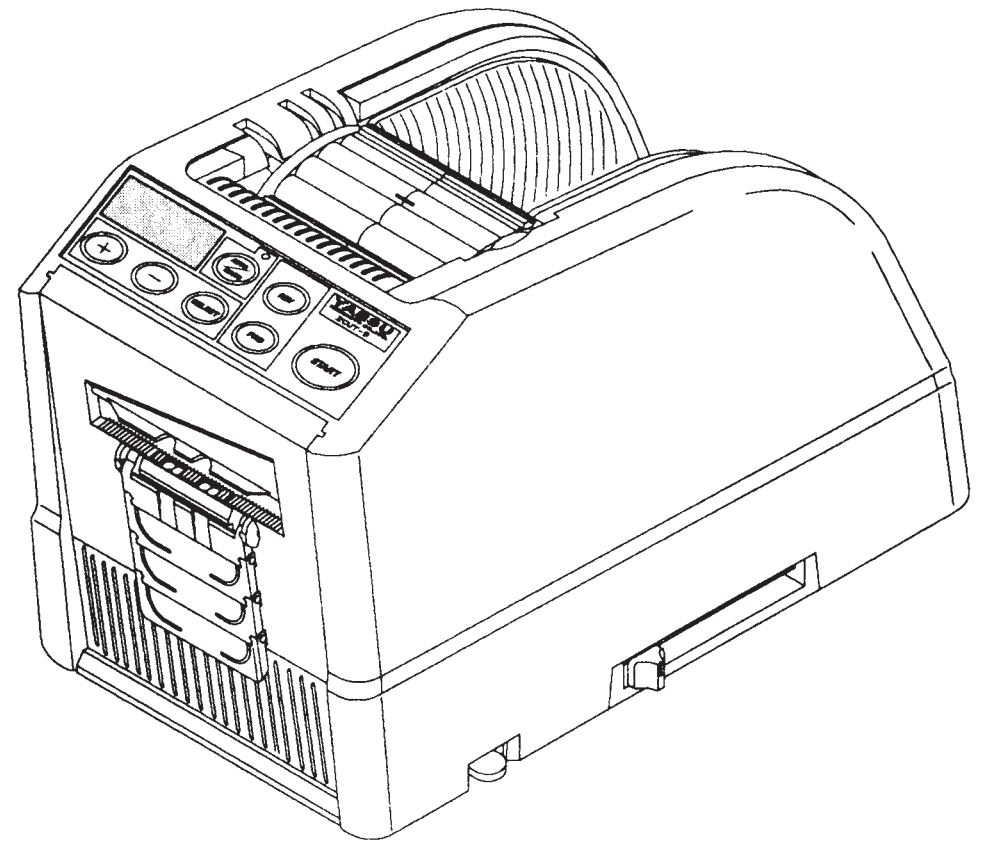

# Read Before Use

Thank you very much for buying our tape dispenser ZCUT-9. ZCUT-9 is a very compact, special well equipped machine which can cut and dispense various kinds of tape, including non-adhesive products.

Please read this Instruction Manual carefully.  
For your safety, please always keep this Instruction Manual for reference, retraining and trouble shooting.

## Contents

- P2 Read Before Use
- P3 Safety Instructions
- P3 Definition of Warning and Caution Symbols
- P4 Warning
- P5-6 Identification of Parts
- P7 Load the Tape
- P8 Set the Tape Length
- P8-9 Mode Setting
- P10 How to Manage a Curling Tape
- P10 Use Narrow Tape / Use Two Rolls in a Same Time
- P10 Other Functions
- P11 Replace the Blade Unit
- P11-12 Maintenance
- P12 Error Messages
- P13 Trouble Shooting
- P13 Specifications
- P14 Warranty

MEMO

---

---

---

---

---

---

---

---

---

---

---

---

---

---

---

---

---

---

---

---

---

---

---

We warrant to the original purchaser of the product that will be free from defects in material or workmanship for as long as the original purchaser owns the product, when given normal wear and proper usage.

The limited warranty for the machine shall be for a period of 180 days from the date of purchase.

The spare parts such as Cutting Blades, Rollers, are not covered under the warranty period as they are considered as "wear parts".

This warranty is only valid if the product:

- ◆ Was not damaged while being installed.
- ◆ Was operated in accordance with products's specifications, instructions and any technical support directions.
- ◆ Was not modified or damaged by tempering, user error, accident, disaster, abuse, misuse, power supply, power application, alternation, repair, modification, a fix or replacement by someone other than the original product.

## Safety Instructions

The safety guidelines in this Instruction Manual must be observed in order to prevent damage to the machine or injury to the operator or other persons.

The safety guidelines prescribed "Warning " and "Caution" describe possible injury or damage that may be suffered from operating or maintaining the machine in a manner other than as described in this Instruction Manual.

Read and follow the safety precautions carefully before reading the Instruction Manual.

## Definition of Warning and Caution Symbols



**Warning**

Indicates a potentially hazardous situation which if not avoided, could result in death or serious injury.



**Caution**

Indicate that miss-handling may result in danger and that the operator is at risk of injury, or the machine is at risk of damage.



Indicates Caution

A symbol within the triangle, or the description, will indicate a specific hazard.



A Prohibited Action

A symbol within the circle, or the description, will indicate prohibited action.



A Required Action

A symbol within the circle, or the description, will indicate the required action.

## Warning

 Do not plug in, unplug the cord, or operate the machine with wet hands.

Failure to observe this may result in injury due to electric shock.

 Never insert your finger, or any other body part, or any foreign object into the machine.

Failure to observe this may result in injury.

 Keep hair or loose clothing away from the machine while it is operating.

Failure to observe this may result in injury.

 This machine is intended for industrial use only.  
Do not allow untrained operators or children to operate the machine.

Failure to observe this may result in injury.

 Turn off the power switch and unplug the machine prior to replacing the blade unit or performing any maintenance on the machine.

Failure to observe this may result in serious injury.

 Do not use this machine for anything other than its specified applications.

Use of the machine for any unintended applications can cause injury to the operator or failure of the machine.

## Trouble Shooting

Before returning the machine for repairing, please check the followings.

The POWER SWITCH is on but the machine can not run.	The AC CORD is loosen. The FUSE has been blown.	Check the AC CORD then plug in the outlet firmly. Replace the FUSE. Stop using the machine immediately even though the FUSE is blown again after replace.
After removing piece of tape, the next piece does not feed under AUTO mode.	The mode is set MANUAL. Some debris are covering on the SENSORS. The tape can not goes through the SENSORS. The tape has extremely low reflectance.	Set the mode to AUTO. Remove the debris. Use SEPARATOR to narrow the tape lesser than 15mm, Do not bring strong illuminant close around the SENSORS. Some types of tape may not be used under AUTO mode.
The BLADE can not move smoothly.	The BLADE UNIT is not in a proper position.	Check the BLADE UNIT and push down on the housing firmly.
The length of the tape is different from the set length.	The adhesive of tape is too strong. The elasticity of tape is too strong.	Correct the setting after cutting several test pieces.
Tape curls excessively.	The machine is not grounded. The ROLLER LOCK is disengaged.	Check ground on cord. Engage the ROLLER LOCK to apply tension.



If the machine still can not operate properly, stop using the machine immediately and contact vendor for repair authorization.

## Specifications

Power Requirement	100V, 120V, 220-240V
Input Voltage Range	±5%
Wattage	25W
Dimensions	116mm(W) x 140mm(H) x 213mm(D)
Weight	2.5 KG.
Body Material	Anti-Static ABS
Tape Length	5mm ~ 999mm
Tape Width	6mm~60mm
Feeding Speed	200mm/sec. (using Craft Tape)
Max. Outside Dia. of Roll	300 mm
Accessories	Power Cord 2A Fuse (Built-In Inlet) Separator / Guide Plate / Blade Oil / Tweezers

Remarks ◆The specifications are subject to change without prior notice.  
◆The length of the tape may differ from the set length depending upon the type of the tape or its condition.  
◆Some types of tape available with the machine may not be cut depending upon conditions.

Always keep clean around the SENSORS.

To protect the SENSOR, clean the openings after removed the BLADE UNIT carefully.

### Clean the Body

Put neutral detergent on a damp cloth to clean the body.  
Do not use alcohol or solvent to clean the plastic parts.

### Error Messages

The buzzer will has a sound then a message will flash and show on the DISPLAY.

#### E-02 Blade is Out of Position

A signal shows that the blade is not installed well or machine stops because of the thickness or hardness of the tape.

- ◆ Turn the POWER SWITCH off.
- ◆ Remove the BLADE UNIT by releasing the BLADE UNIT RELEASING LEVER then lift the assembly out of the body.
- ◆ Turn the POWER SWITCH on.
- ◆ Press the FWD BUTTON and feed -in the tape once, cut the tape in between the TAPE OUTLET and the BLADE UNIT by scissor.
- ◆ Press the REV BUTTON to remove the tape.
- ◆ Clean the BLADE UNIT and lubricate the LOWER BLADE GUIDE.
- ◆ Check the lower blade position and replace the BLADE UNIT.

#### E-03 Motor is Stopped

Indicates that the motor is stopped because of overload.

- ◆ Press the START BUTTON to clear the error message.
- ◆ Press the REV BUTTON to remove the tape.
- ◆ Turn the POWER SWITCH off.
- ◆ Check the BLADE UNIT and TAPE OUTLET carefully.
- ◆ Clear and take away the spare tape waste or sticky residue by using TWEEZERS.

! Do not touch the Blade when you are correcting an error under POWER SWITCH is on.

! Turn off the POWER SWITCH and stop using the machine. If the machine cannot work normally after correcting the error. It seems that nothing wrong without any error messages.

! Do not use the tape if static electricity generates over 1000V. It may cause failure to the machine.

**E-02**

POWER SWITCH IS OFF



REMOVE BLADE UNIT



POWER SWITCH IS ON



(START) CLEAR THE ERROR



(FWD) FEED THE TAPE



(REV) REMOVE THE TAPE



CLEAR THE BLADE



SET THE TAPE

**E-03**

(START) CLEAR THE ERROR



(REV) REMOVE THE TAPE



SET THE TAPE

## IDENTIFICATION OF PARTS

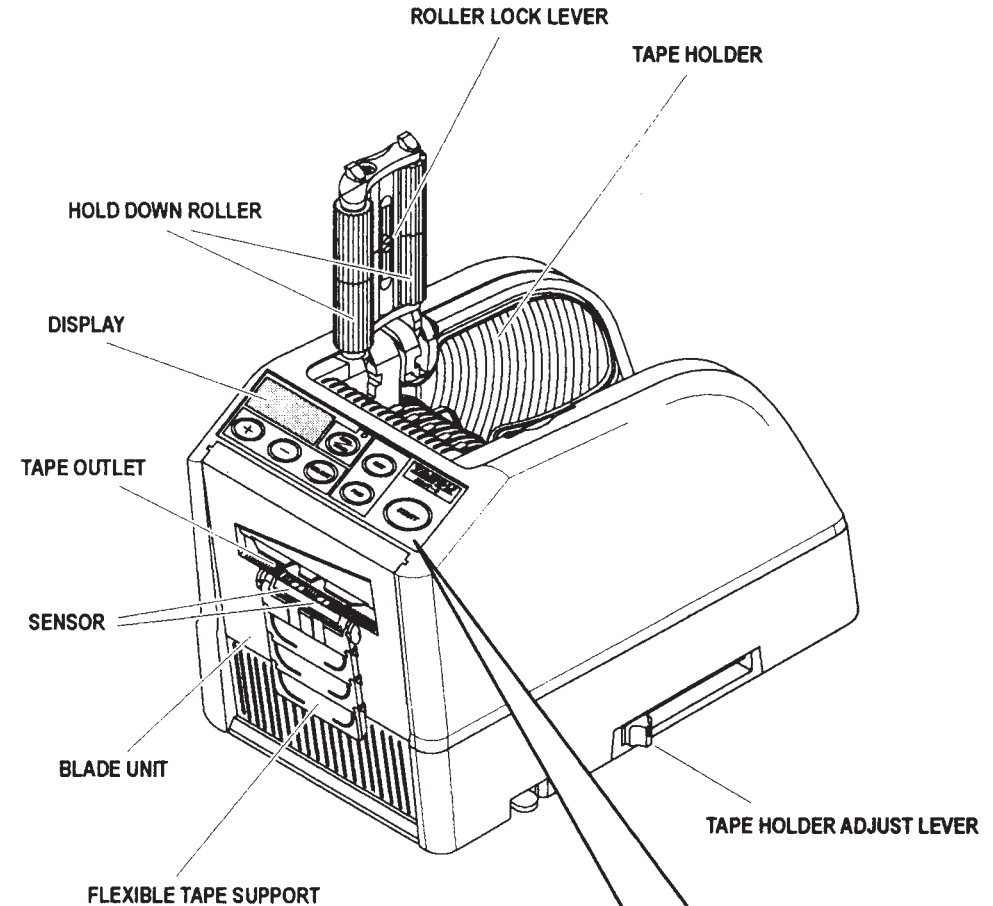

### CONTROL PANEL

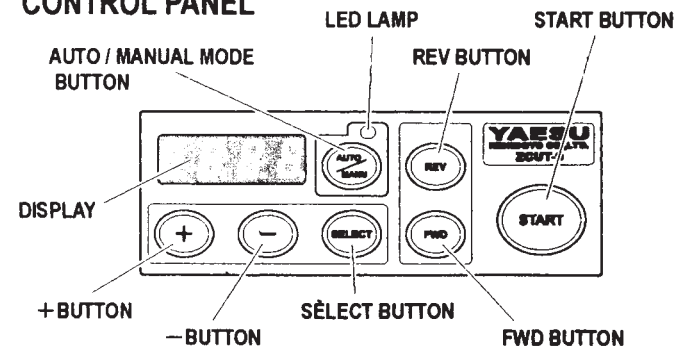

## IDENTIFICATION OF PARTS

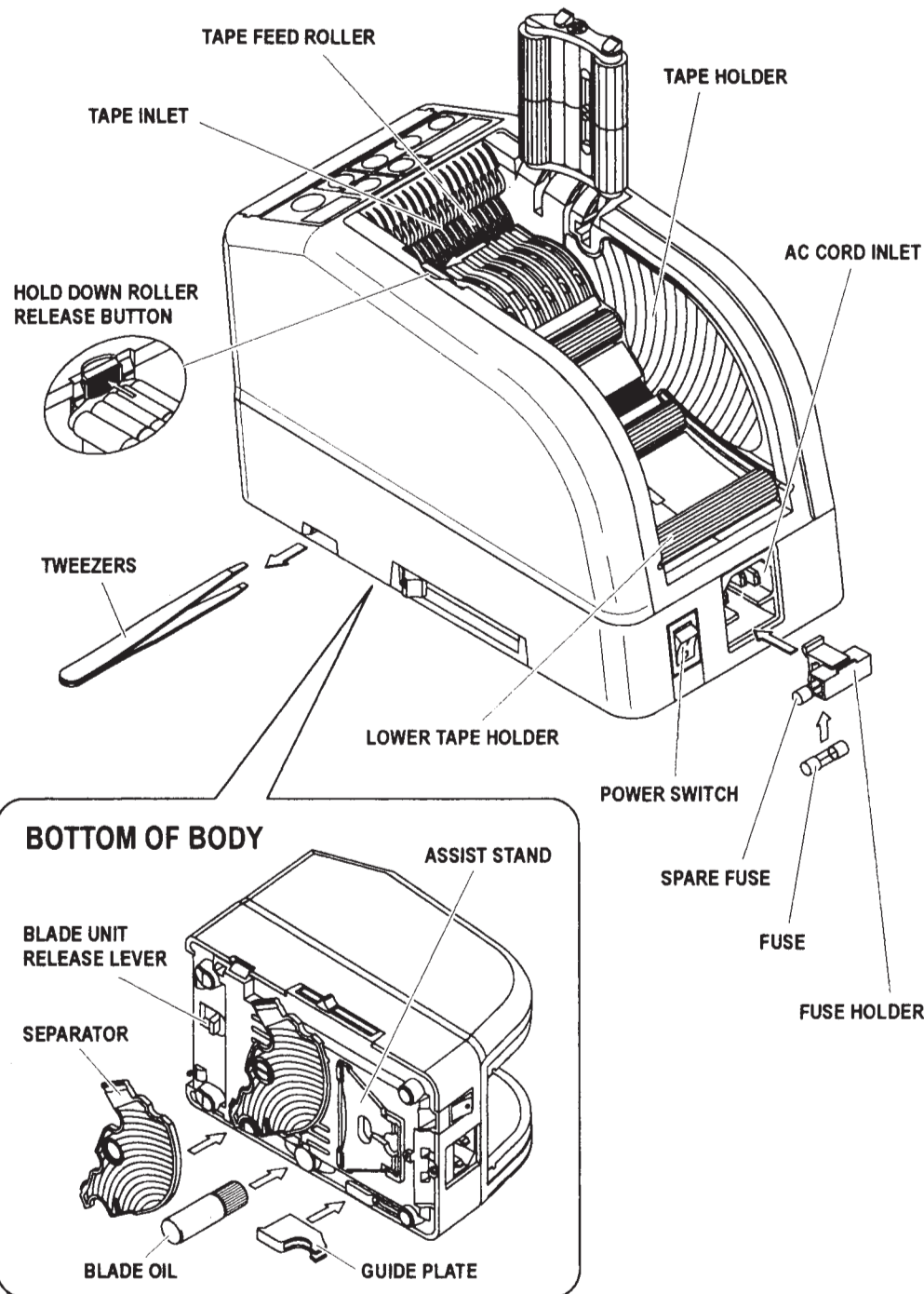

## Replace the Blade Unit

Only Blade is not accepted to be replaced.  
It needs to change with the whole Blade Unit.

- ◆ Turn the POWER SWITCH off.
- ◆ Remove the BLADE UNIT by releasing the BLADE UNIT RELEASE LEVER.
- ◆ Install the new BLADE UNIT into the body.
- ◆ Push down on the housing firmly until it is locked.  
Make sure that the lower blade is positioned properly, turn the BLADE UNIT over and take a look the bottom edge of the lower blade.

## Maintenance

**!** Whenever you clean or replace the BLADE UNIT, do not touch the sharp edge of the blade.

### Clean the Blade Unit

When cutting tapes with heavy adhesive, the residue will remain on the blade gradually.

It is necessary to remove the BLADE UNIT for cleaning.

- ◆ Turn the POWER SWITCH off.
- ◆ Remove the BLADE UNIT by releasing BLADE UNIT RELEASE LEVER.
- ◆ Put some alcohol on a clean dry cloth, or use a swab to remove the residue.
- ◆ Replace the BLADE UNIT.

### Lubricate the Blade

Lubricate the blade in order to prevent residue stick on the blade.

- ◆ Turn the POWER SWITCH off.
- ◆ Remove the BLADE UNIT from the body.
- ◆ Locate three oil holes on the back side of the top blade.
- ◆ Drip one drop of BLADE OIL into each hole.
- ◆ Also lubricate LOWER BLADE GUIDE.
- ◆ Do not lubricate over and over again.  
Wipe the spare oil away by using cotton cloth.
- ◆ Replace the BLADE UNIT into the body.
- ◆ Turn the POWER SWITCH on.  
Make several test cuts in order to make sure the tape will not fall down from the TAPE OUTLET.

### Clean the Sensors

There are two pairs of SENSORS below the TAPE OUTLET.  
If the opening is covered by tape residue or debris, the SENSORS will not detect the presence tape.

## REMOVE BLADE UNIT

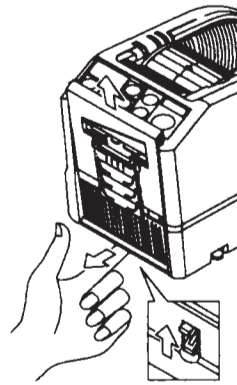

## INSTALL BLADE UNIT

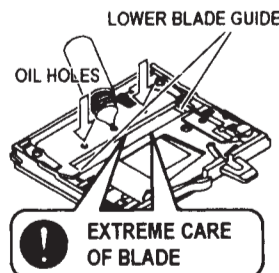
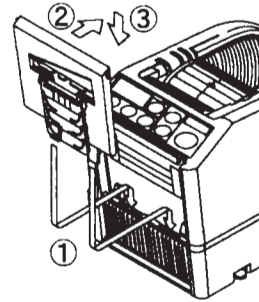

**BE CAREFUL TO HANDLE THE SENSORS**

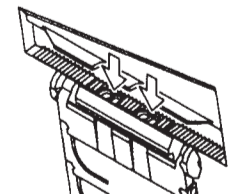

## How to Manage a Curling Tape

- ◆ Press the HOLD DOWN ROLLER RELEASE BUTTON in order to open the HOLD DOWN ROLLER UNIT.
- ◆ Extend the ROLLER LOCK LEVER so that the roller will not turn.
- ◆ Close the HOLD DOWN ROLLER UNIT.  
With the rollers locked, the tension may cause the length to vary.  
Cut several test pieces in order to adjust the length if needed..

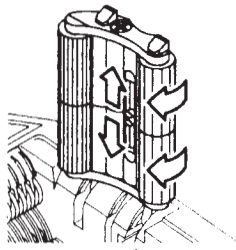

## Use Narrow Tape / Use Two Rolls in a Same Time

If the tape is lesser than 15 mm width or you want to dispense two rolls in a same time, use the SEPARATOR.

Cut lesser than 10 mm width of tape, put the GUIDE PLATE on the SEPARATOR.

- ◆ Remove the SEPARATOR from the bottom of body.
- ◆ Open the HOLD DOWN ROLLER UNIT
- ◆ Insert the SEPARATOR into the body by slotting in to the bottom of the cavity.
- ◆ When you cut the tape lesser than 10 mm, put the GUIDE PLATE onto the Separator.
- ◆ Place one roll of the tape on either side by inserting a SEPARATOR for loading tape.
- ◆ To hold the tape by adjusting TAPE HOLDERS, it is unnecessary to push the SEPARATOR out of position.  
When dispensing two roll of tapes in a same time, it is a must to feed-in both of its' length in a same time
- ◆ Remove the first piece of tape
- ◆ When the second piece of the tape is removed, both side of tapes are also dispensed.

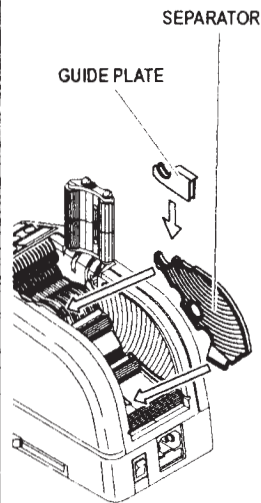

## Other Functions

### FLEXIBLE TAPE SUPPORT

When you cut the tape longer or cut non-adhesive tape / film, use FLEXIBLE TAPE SUPPORT in order to avoid the tape fall down.

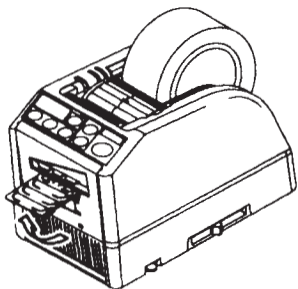

### ASSIST STAND

Based on the tape material or workpiece purpose, use the ASSIST STAND in order to let the body of machine towards a lower level.

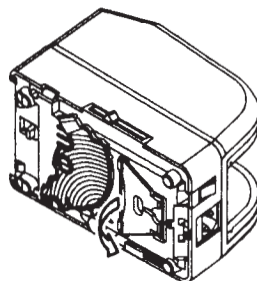

## Load the Tape

- ◆ Plug in the AC CORD to the AC CORD INLET.
- ◆ Make sure the POWER SWITCH is off then plug into an appropriate grounded AC outlet.
- ◆ Turn the POWER SWITCH on.  
When the POWER SWITCH is turned on, a buzzer will has a sound.  
At this moment, the mode is set to MANUAL.
- ◆ Press the HOLD DOWN ROLLER RELEASE BUTTON.
- ◆ Place a roll of tape in the machine.
- ◆ Hold the tape by adjusting the TAPE HOLDERS.  
Adjust the TAPE HOLDERS to a proper width, slide the TAPE HOLDER ADJUST LEVER from the front to the rear of the machin then close it.  
The TAPE HOLDERS should hold the roll lightly in the center of the cavity of the machine.  
This is very important because it keeps the tape in the center.  
The tape passes over the SENSOR in front of the BLADE UNIT.  
To support a larger roll of tape, pull the LOWER HOLDER out.
- ◆ Put the tape on the TAPE FEED ROLLER.
- ◆ Press the FWD BUTTON until the tape comes out from the TAPE OUTLET.  
When using a strong sticky adhesive tape, pull a little bit tape out in positioning into the TAPE INLET.  
Press the FWD BUTTON continuously for a few seconds, also help the tape in positioning in the TAPE INLET.
- ◆ After the tape is loaded and the TAPE HOLDERS are adjusted, close the HOLD DOWN ROLLER UNIT.
- ◆ Press the START BUTTON.  
Remove the first piece of tape and discard it.

Now your ZCUT-9 is ready to use.

! Always use Tweezers to remove tape.

! Whenever set the tape, make sure that adhesive side of tape is always faced down.

- ◆ When you take the roll of tape out from the machine, pull the tape backward and pressing REV BUTTON.

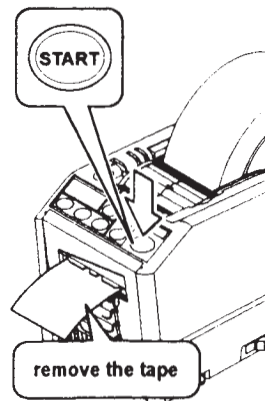
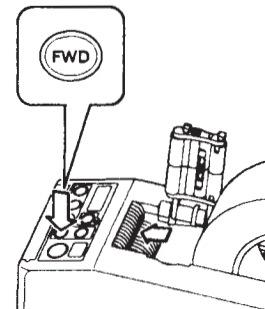
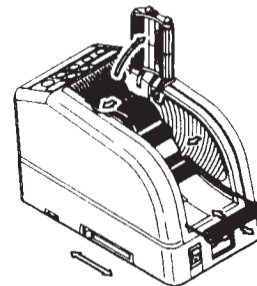
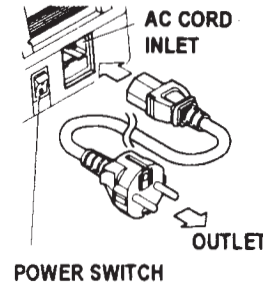

## Set the Tape Length

- ◆ Make sure that DISPLAY indicating <cutting length>.

The cutting length is always indicates in some alphabets like A,b,C,d,E,F.

- ◆ Set the cutting length.

Set your needed length by using +/- BUTTON.

The cutting length is adjustable in between 5 mm to 999 mm.

Can set six different length by using SELECT BUTTON.

If you press +/- BUTTON in a short while, the length in changed to 1 mm.

And if you press +/- BUTTON longer, it shows fast forward.

### Caution

The actual length is differ from the displayed length depends on the type of the tape and its condition.

When cutting short length of tape, the length may not cut consistently or tape is jammed.

Try several test cuts to insure proper operation.

### INDICATE CUTTING LENGTH

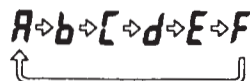

### SET THE CUTTING LENGTH

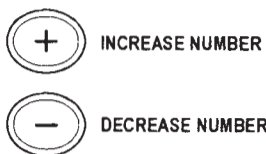

## Mode Setting

### MANUAL MODE

- ◆ Make sure that blue LED LAMP is off.

When the LED LAMP is flashing or turned on, press AUTO/MANUAL MODE and turn off the LED LAMP.

- ◆ Press the START BUTTON once, the machine will feed-in a piece of tape then cut it out based on your set length.

- ◆ To cut another piece, press START BUTTON again.

### AUTO MODE

- ◆ Make sure that the LED LAMP is flashing.

When the LED LAMP's lights are off, press AUTO/MANUAL BUTTON and let the LED LAMP to flash.

- ◆ Press the START BUTTON once, the machine will feed-in a piece of tape then cut it out based on your set length.

When that piece of tape is removed, the machine will feed-in another piece then cut it out.

The machine will feed-in and cut a new piece of tape once the piece of tape is removed.

### SET AUTO / MANUAL

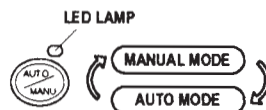

### MANUAL MODE

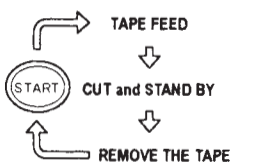

### AUTO MODE

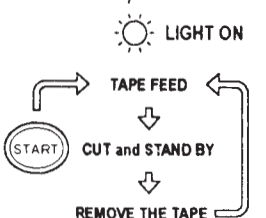

## P-MODE (Preset Mode)

The machine is able to be programmed.

A signal will be shown based on your selected quantity of pieces and it will all cut out. (Maximum 999 pieces.)

A buzzer will has sound when the program is finished.

You can use the mode either MANUAL or AUTO.

- ◆ Press SELECT BUTTON to choose your needed length.
- ◆ Press SELECT BUTTON for three seconds then it will indicates "Lcon".
- ◆ Press SELECT BUTTON again then it will indicates "P".
- ◆ Use +/- BUTTON and set your needed number of quantity.
- ◆ Choose AUTO or MANUAL by USING AUTO/MANUAL BUTTON.
- ◆ When you press the START BUTTON, the machine will feed-in and cut out a piece of tape for testing purpose.  
To operate the machine by using MANUAL MODE, press the START BUTTON and feed-in a piece of tape after take it out.  
To operate the machine by using AUTO MODE, the machine will feed-in a piece of tape automatically.

- ◆ The signal shows numbers backwards when feeding-in another piece of tape.

- ◆ When the DISPLAY indicates "0", the buzzer will has a sound.

The DISPLAY indicates the number of pieces that is preset.

Please wait until the buzzer stops.

If you take the tape out before the buzzer stops, the LED LAMP will flash so you need to press the START SWITCH again.

- ◆ If you try to change the mode (AUTO/MANUAL) when machine is operating, just press AUTO/MANUAL BUTTON.

## L-Mode (Loop Mode)

You can preset the quantity of piece which will be cut out. (Maximum 999 pieces)  
The machine will cut out the pieces based on your selected quantities then it will stop.

- ◆ Press the SELECT BUTTON and decide the length of tape.
- ◆ Press and hold SELECT BUTTON so that DISPLAY will indicates "Lcon".
- ◆ Set the number of pieces to be cut out by using +/- BUTTON.
- ◆ When you press the START BUTTON, DISPLAY indicates a signal shows numbers backwards and cutting continuously.

When the DISPLAY indicates "0", the buzzer will has sound then the machine is stopped.

To stop the mahicne while running under L-MODE, press the START BUTTON.

## P-MODE

### INDICATE CUTTING LENGTH

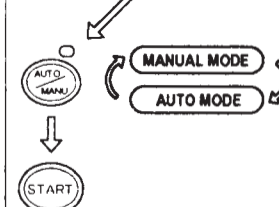
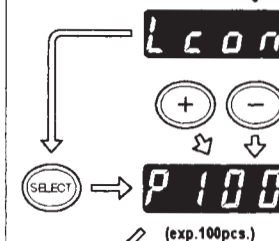

## L-MODE

### INDICATE CUTTING LENGTH

